

# 2400-01 FRONT END PROCESSOR

## MAINTENANCE & SUPPORT GUIDE



The information in this document has been carefully checked and is believed to be entirely reliable. However, no responsibility is assumed for inaccuracies. Furthermore, Cyclone Microsystems, Inc. reserves the right to make changes to any products herein to improve reliability, function, or design. Cyclone Microsystems, Inc. neither assumes any liability arising out of the application or use of any product or circuit described herein, nor does it convey any license under its right or the rights of others.

Revision 1.2, January 2003

Cyclone P/N 800-2400-01

Copyright 2003 by Cyclone Microsystems, Inc.

## Release History for 2400 Series Front End Processors January 15, 2003

This document contains changes applicable to all 2400 Series FEP Maintenance & Support Guides.

- 1.1 Cyclone Microsystems Inc. has released a new firmware revision, Revision 2.3, to support new revisions of the 2400 FEP host and datalink boards. The new firmware is designated in the ordering information with the suffix “**T3**”. All shipments of 2400 Series FEPs and individual boards ordered as spares as of December 12, 2002, will be loaded with the T3 firmware. Replacement board part numbers and corresponding CLEI codes can be found in **section 5.1**, under Serviceable Components.

**CHAPTER 1**  
**PRODUCT OVERVIEW**

1.1 INTRODUCTION ..... 1-1

1.2 SPECIFICATIONS ..... 1-1

**CHAPTER 2**  
**CONFIGURATION & CONNECTORS**

2.1 PHYSICAL CONFIGURATION..... 2-1

2.2 SWITCHES ..... 2-4

    2.2.1 FEP Power Supply Switches ..... 2-4

    2.2.2 FEP Reset Switch ..... 2-5

2.3 CONNECTORS ..... 2-5

    2.3.1 Power Connector ..... 2-5

        2.3.1.1 DC Power Connectors (600-2400-01-D0) ..... 2-5

        2.3.1.2 AC Power Connectors (600-2400-01-A0) ..... 2-6

        2.3.1.3 Ground Stud for 600-2400-01-A0 and 600-2400-01-D0 ..... 2-6

    2.3.2 CPCI-810 Console Connector ..... 2-6

    2.3.3 Ethernet Port Connector ..... 2-7

    2.3.4 Serial Port Connector..... 2-7

**CHAPTER 3**  
**FEP INITIALIZATION & BUILT-IN SELF TEST**

3.1 FEP INITIALIZATION AND BUILT-IN SELF TEST ..... 3-1

**CHAPTER 4**  
**PERIODIC MAINTENANCE**

4.1 PERIODIC MAINTENANCE ..... 4-1

**CHAPTER 5**  
**SERVICEABLE COMPONENTS**

5.1 SERVICEABLE COMPONENTS ..... 5-1

5.2 BOARD REMOVAL AND INSTALLATION ..... 5-1

    5.2.1 Board Removal ..... 5-1

    5.2.2 Board Installation ..... 5-2

5.3 FAN TRAY REMOVAL AND INSTALLATION ..... 5-2

    5.3.1 Fan / Filter Access Panel Removal..... 5-2

    5.3.2 Fan/Filter Access Panel Installation ..... 5-2

5.4 POWER SUPPLY REMOVAL AND INSTALLATION ..... 5-2

    5.4.1 Power Supply Removal..... 5-2

    5.4.2 Power Supply Installation..... 5-2

**CHAPTER 6**  
**RELIABILITY PREDICTIONS**

6.1 METHODOLOGY ..... 6-1

6.2 ASSUMPTIONS ..... 6-1

6.3 CONFIGURATION ..... 6-1

6.4 RESULTS ..... 6-1

# CONTENTS



## CHAPTER 7 WARRANTY

7.1 OVERVIEW .....	7-1
7.2 HARDWARE.....	7-1
7.3 SOFTWARE AND FIRMWARE .....	7-1
7.4 EFFECTIVE PERIOD OF WARRANTY .....	7-1
7.5 REPAIRED OR REPLACEMENT PRODUCT (OUT-OF-WARRANTY) .....	7-1
7.6 SERVICE POLICY .....	7-2

## APPENDIX A MANUALS

A.1 ADDITIONAL INFORMATION .....	A-1
----------------------------------	-----



**LIST OF FIGURES**

Figure 1-1. FEP Part Numbering ..... 1-1  
Figure 2-1. 600-2400-01-D0 FEP Front Panel..... 2-1  
Figure 2-2. 600-2400-01-A0 FEP Front Panel..... 2-2  
Figure 2-3. 600-2400-01 FEP Front Panel LEDs..... 2-3  
Figure 2-4. DC Power Connector..... 2-5  
Figure 2-5. AC Power Connector ..... 2-6  
Figure 4-1. Air Filter Replacement ..... 4-2

**LIST OF TABLES**

Table 1-1. 600-2400-01 Specifications ..... 1-2  
Table 2-1. 600-2400-01-D0 FEP Front Panel Description..... 2-1  
Table 2-2. 600-2400-01-A0 FEP Front Panel Description..... 2-2  
Table 2-3. 600-2400-01 FEP Front Panel LED Description..... 2-3  
Table 2-4. Ground Stud ..... 2-6  
Table 2-5. Console Port Connector ..... 2-7  
Table 2-6. Ethernet Port Connector..... 2-7  
Table 2-7. Serial Port Connector Pin Assignments ..... 2-8  
Table 3-1. Initialization and Self Test LEDs..... 3-1  
Table 4-1. Air Filter Replacement ..... 4-1  
Table 5-1. CLEI Number and Barcode ..... 5-1

## 1.1 INTRODUCTION

The 2400-01 Front End Processor is a system featuring eight low speed serial links and two Ethernet ports. The low speed serial links can run at 64 kbps or 56 kbps and can be configured by software to use a V.35 or EIA-530-A interface. The system uses two PowerPC processors. The 2400-01 is available in AC or DC versions and features two redundant, hot swappable removable power supplies. The 2400-01 system also monitors power supply, fan status and temperature in an effort to detect and provide early alert to component failures.

The part numbering system for the 600-2400 series of FEPs is as shown in Figure 1-1.

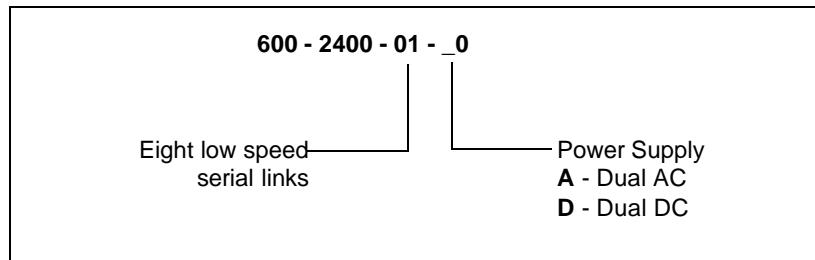

**Figure 1-1. FEP Part Numbering**

## 1.2 SPECIFICATIONS

Table 1-1 lists the specifications for the 2400-01 series Front End Processor. Cooling air input is on the left side of the unit and the air exhaust is on the right side. Airflow should not be restricted; a minimum of one inch clearance on each side is required.

**Table 1-1. 600-2400-01 Specifications**

<b>Physical</b>	Height	5.25 inches
	Width	17.5 inches
	Depth	12 inches
	Other	19 inch rack mountable
	Weight	15 lbs
<b>Electrical - AC version</b>	<b>(600-2400-01-A0)</b>	
	Voltage:	90 - 264 Vac
	Current (Max):	3A
	Power Dissipation:	219 BTU/hr.
	Frequency:	47 - 63 Hz
Connector:	Ethernet ports: 10/100 BaseTx RJ45 Console Serial ports: RJ11 Serial ports: Switchable between V.35 and EIA-530-A	
<b>Electrical - DC version</b>	<b>(600-2400-01-D0)</b>	
	Voltage:	36 - 72 Vdc
	Current (Max):	6.5A
	Power Dissipation:	219 BTU/hr.
	Connector:	Ethernet ports: 10/100 BaseTx RJ45 Console Serial ports: RJ11 Serial ports: Switchable between V.35 and EIA-530-A
<b>Environmental</b>	Operating Temperature	0 to 55 Degrees Celsius
	Relative Humidity	0% to 95% (non-condensing)
	Storage Temperature	-55 to 125 Degrees Celsius
<b>Regulatory Compliance</b>	UL1950 CUL C22.2 No. 950, CE Marking, FCC Class A <p><u>Note:</u> This equipment has been tested and found to comply with the limits for a Class A digital device, pursuant to Part 15 of the FCC Rules. These limits are designed to provide reasonable protection against harmful interference when the equipment is operated in a commercial environment. This equipment generates, uses and can radiate radio frequency energy and, if not installed and used in accordance with the instruction manual, may cause harmful interference to radio communications. Operation of this equipment in a residential area is likely to cause harmful interference in which case the user will be required to correct the interference at his own expense.</p> <p><u>Caution:</u> Changes or modifications to this equipment not expressly approved by the party responsible for compliance could void the user's authority to operate the equipment.</p> <p>This digital apparatus does not exceed the Class A limits for radio noise emissions from digital apparatus set out in the Radio Interference Regulations of the Canadian Department of Communication.</p> <p>Le present appareil numerique n'emmet pas de bruits radioelectriques depassant les limites applicables aux appareils numeriques de las classe A prescrites dans le Reglement sur le brouillage radioelectrique edicte par le ministere des Communications du Canada.</p>	

**2.1 PHYSICAL CONFIGURATION**

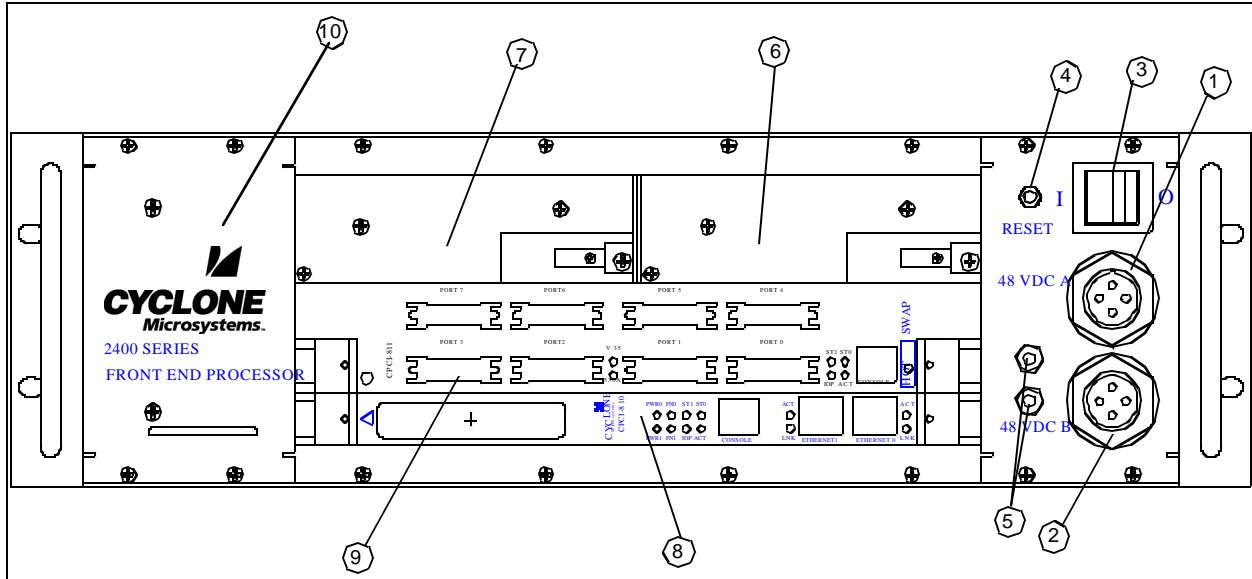

**Figure 2-1. 600-2400-01-D0 FEP Front Panel**

Figure 2-1 shows a front view of the FEP unit with DC power supplies. Table 2-1 identifies each item.

**Table 2-1. 600-2400-01-D0 FEP Front Panel Description**

No.	Name
1	Power Connector A
2	Power Connector B
3	FEP Power supply ON/OFF Switch
4	FEP Reset Switch
5	FEP Ground Lugs
6	Power Supply A
7	Power Supply B
8	CPCI-810
9	CPCI-811-08
10	Fan/Filter Assembly



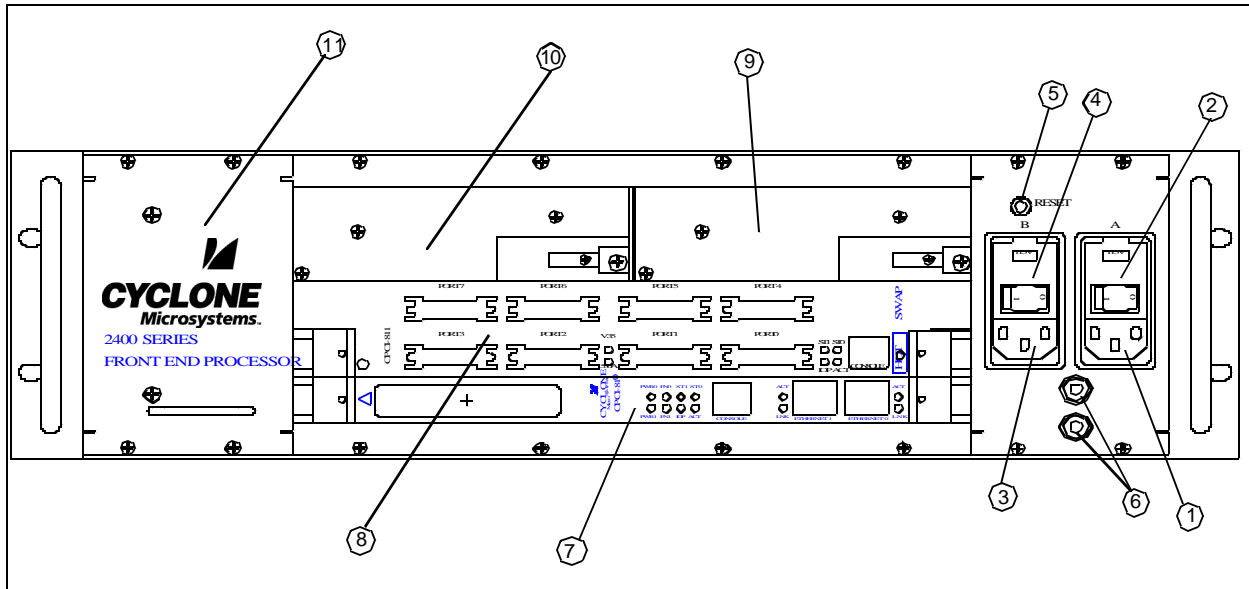

**Figure 2-2. 600-2400-01-A0 FEP Front Panel**

Figure 2-2 shows a front view of the FEP unit with AC power supplies. Table 2-2 identifies each item.

**Table 2-2. 600-2400-01-A0 FEP Front Panel Description**

No.	Name
1	Power Connector A
2	FEP Power supply ON/OFF Switch A
3	Power Connector B
4	FEP Power supply ON/OFF Switch B
5	FEP Reset Switch
6	FEP Ground Lugs
7	CPCI-810
8	CPCI-811-08
9	Power Supply A
10	Power Supply B
11	Fan/Filter Assembly

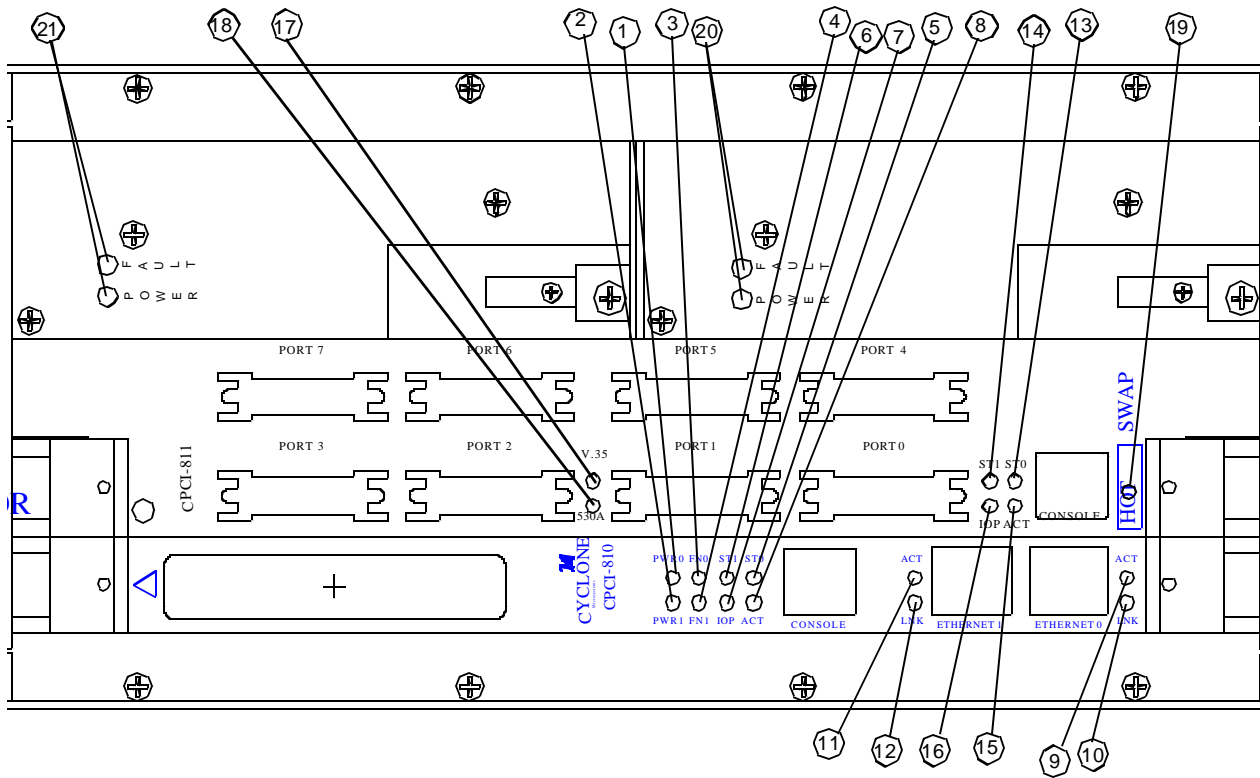

Figure 2-3. 600-2400-01 FEP Front Panel LEDs

Figure 2-3 shows a front view of the FEP unit. Table 2-3 briefly describes each item.

Table 2-3. 600-2400-01 FEP Front Panel LED Description

No.	Name	Description
1	CPCI-810 PWR0	Turns on and remains on for power good condition of power supply A and turns off for power failure.
2	CPCI-810 PWR1	Turns on and remains on for power good condition of power supply B.
3	CPCI-810 FN0	Turns on and remains on for FAN0 good condition and turns off for FAN0 failure.
4	CPCI-810 FN1	Turns on and remains on for FAN1 good condition and turns off for FAN1 failure.
5	CPCI-810 ST0	Indicates status 0 for CPCI-810 and will light And remain on for some time after a reset or power-on and turn off.
6	CPCI-810 ST1	Indicates status 1 for CPCI-810 and will light and remain on for some time after a reset or power-on and turn off.
7	CPCI-810 IOP	Indicates IOP for CPCI-810 and will light for a short time after a reset or power on and then turn off.

8	CPCI-810 ACT	Indicates CPCI-810 activity and will blink and/or vary in intensity as CPCI-810 performs different operations.
9	CPCI-810 Ethernet 0 ACT	Indicates network activity for port 0 and will blink during transmit and receive activity.
10	CPCI-810 Ethernet 0 LNK	Indicates link integrity for Ethernet port 0 and will remain on continuously if port 0 is connected to a functional network or Ethernet port.
11	CPCI-810 Ethernet 1 ACT	Indicates network activity for port 1 and will blink during transmit and receive activity.
12	CPCI-810 Ethernet 1 LNK	Indicates link integrity for Ethernet port 1 and will remain on continuously if port 1 is connected to a functional network or Ethernet port.
13	CPCI-811 ST0	Indicates status 0 for CPCI-811 and will light for a short time after reset or power-on, then turn off.
14	CPCI-811 ST1	Indicates status 1 for CPCI-811 and will light for a short time after reset or power-on and then turn off.
15	CPCI-811 ACT	Indicates CPCI-811 activity and will remain on for some time then turn off after reset or power-on.
16	CPCI-811 IOP	Indicates IOP for CPCI-811 and will light for a short time after reset or power-on and then turn off.
17	CPCI-811 V.35	This indicates V.35 interface when lit.
18	CPCI-811 530A	This indicates EIA-530-A interface when lit.
19	Hot Swap	This will illuminate when extraction or insertion of CPCI-811 board takes place when power-on.
20	Power Supply A	The FEP Power Supply green 'POWER' LED is located on the power supply. It illuminates when the power supply is ON. The yellow 'FAULT' LED will light when the power supply is removed or the power supply is faulty, or there is no power supplied to the power entry module.
21	Power Supply B	The FEP Power Supply green 'POWER' LED is located on the power supply. It illuminates when the power supply is ON. The yellow 'FAULT' LED will light when the power supply is removed or the power supply is faulty, or there is no power supplied to the power entry module.

## 2.2 SWITCHES

### 2.2.1 FEP Power Supply Switches

The 600-2400-01-D0 DC unit has a single power switch. This switch enables and disables power from both power entries to both power supplies. The '1' position indicates power supply ON and '0' position indicates power supply OFF.

The 600-2400-01-A0 AC unit has two power switches, each switch associated with one of the power entry modules. AC power switch A enables and disables power entry to power supply A and AC power switch B enables and disables power entry to power supply B.

**2.2.2 FEP Reset Switch**

The FEP Reset Switch is a momentary push-button switch that resets the FEP.

**2.3 CONNECTORS**

**2.3.1 Power Connector**

There are two power supply connectors on the right hand side of the FEP.

**2.3.1.1 DC Power Connectors (600-2400-01-D0)**

The DC power connector is a 4-pin connector. See Figure 2-4.

Mating Connector p/n -

ITT Cannon P/N MS 3476 W14 4S

or

ITT Cannon P/N MS 3475 W14 4S

or

Deutsch P/N MS 3475 W14 4S

The cable clamp and Backshell for Deutsch P/N MS 3475 W14 4S used is -

Deutsch Backshell P/N 94002-14-3014

Deutsch Cable Clamp P/N 9400314-3014

The Backshell for ITT Cannon P/N MS 3475 W14 4S used is -

ITT Cannon Backshell (shell size 14, type S) P/N 057-0685-002

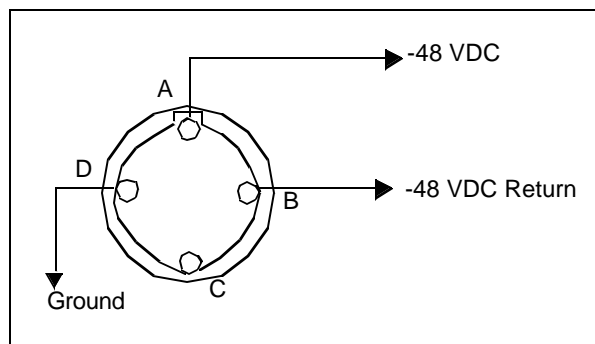

**Figure 2-4. DC Power Connector**

The color code for wire gauge for 600-2400-01-D0 for DC power mating connector is as follows:

Red	+48VDC
Black	-48VDC Return
Green & White	Ground

**2.3.1.2 AC Power Connectors (600-2400-01-A0)**

The AC power connector is a 3-pin connector. See Figure 2-5.

The power Connector is a standard IEC type recessed power receptacle.

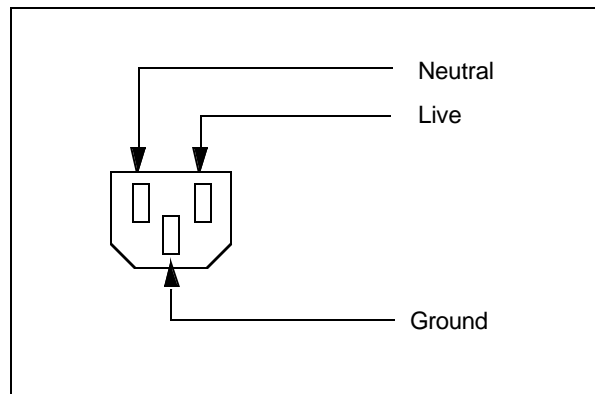

**Figure 2-5. AC Power Connector**

**2.3.1.3 Ground Stud for 600-2400-01-A0 and 600-2400-01-D0**

The ground stud used for 600-2400-01-A0 and 600-2400-01-D0 is Hybricon’s # 10, and either # 10 or # 16 awg wire for earth ground can be used. Following are the AMP part numbers:

**Table 2-4. Ground Stud**

# 10 Stud	# 10-12 awg	amp 2-36161-2
#10 Stud	# 14-16 awg	amp 36161

**2.3.2 CPCI-810 Console Connector**

The CPCI-810 Console Connector is a narrow RJ11 (6 positions) phone jack. The console port is an RS232 serial port using a simple three-wire connection (transmit data, receive data & ground). The connector assignment is as shown in Table 2-4. Normal system operation does not require a connection to the CPCI-810 console connector.

Diagnostic or debug activity may require connecting to the CPCI-810 console connector. A cable connecting the console port to a standard DB25 connector is available from Cyclone Microsystems (P/N 530-2006). A terminal (or PC running a terminal emulation program) should be set up for any band up to 115K band, 8 bits, no parity and 1 stop bit.

**Table 2-5. Console Port Connector**

Pin	Signal	Description
1		N/C
2	GND	Ground
3	TXD	Transmit Data
4	RXD	Receive Data
5		N/C
6		N/C

**2.3.3 Ethernet Port Connector**

The Ethernet Ports Connector 10/100 Base TX is a shielded RJ45 phone jack. The pin assignments are as shown in Table 2-5.

**Table 2-6. Ethernet Port Connector**

Pin	Signal	Description
1	TX+	Transmit + (output)
2	TX-	Transmit - (output)
3	RX+	Receive + (input)
4	TXC	Transmit center tap
5	-	N/C
6	RX-	Receive - (input)
7	RXC	Receive center tap
8	-	N/C

**2.3.4 Serial Port Connector**

The serial port connectors on the CPCI-811 are the Alt-A 26 position connectors found in EIA/TIA-530A. The EIA-530A standard also assigns the differential signals of EIA-422 to the connector. The CPCI-811 uses the DTE (Data Terminal Equipment) pin assignments of EIA-530A for all the signals. The single ended signals of V.35 are assigned to their respective non-inverting signal pin from EIA-530A. Table 2-6 provides a complete list of the signal assignments to the 26 position connectors, including signaling type, signal direction and corresponding ISO-2593 (V.35) connector pin assignment.

**Table 2-7. Serial Port Connector Pin Assignments**

Pin	CCITT Number	V.35 Pin	CPCI-811 Signal	Direction	Description
1	--	A	SHIELD	--	Chassis Ground
2	103	P	TXDA	Output	Transmit Data
3	104	R	RXDA	Input	Receive Data
4	105	**	RTSB	Output	Request to Send
5	106	**	CTSB	Input	Clear to Send
6	--	--	--	--	Not Used
7	102A	B	GND	--	Signal Common
8	109	**	DCDB	Input	Received Line Signal Detector
9	115	X	RXCB	Input	Receiver Signal Timing Element
10	109	F	DCDA	Input	Received Line Signal Detector
11	113	W	TXCB	Output	Transmit Signal Timing Element (DTE Source)
12	114	AA	TXCB	Input	Transmit Signal Timing Element (DCE Source)
13	106	D	CTSA	Input	Clear to Send
14	103	S	TXDB	Output	Transmit Data
15	114	Y	TXCA	Input	Transmit Signal Timing Element (DCE Source)
16	104	T	RXDB	Input	Receive Data
17	115	V	RXCA	Input	Receiver Signal Timing Element
18	--	--	--	--	Not Used
19	105	C	RTSA	Output	Request to Send
20	--	--	--	--	Not Used
21	--	--	--	--	Not Used
22	--	--	--	--	Not Used
23	--	--	--	--	Not Used
24	113	U	TXCA	Output	Transmit Signal Timing Element (DTE Source)
25	--	--	--	--	Not Used
26	--	--	--	--	Not Used

\*\* These signals are not used in V.35 (DCD, CTS and RTS are single ended in V.35).

## CHAPTER 3

# FEP INITIALIZATION & BUILT-IN SELF TEST

### 3.1 FEP INITIALIZATION AND BUILT-IN SELF TEST

The CPCI-810 and CPCI-811 boards display on the IOP, ACT, ST0 and ST1 LEDs the status of the boards initialization and diagnostic self test.

FEP initialization firmware illuminates various user LED patterns after completing early stages of hardware initialization. Should the board fail to boot properly, the LED pattern will indicate the last successfully completed stage of the board initialization sequence. The following table describes the startup LEDs.

**Table 3-1. Initialization and Self Test LEDs**

User LED Pattern	Initialization Stage Passed
ACT	Memory Initialized
ST0	Floating Point Unit Enabled
ST1	Floating Point Unit Initialized
IOP	Instruction Cache Initialized
ACT & ST0	Exception Vectors Initialized
ACT & ST1	BSP Clocks Initialized
ACT & IOP	MPC8240 PCI Bridge Initialized
ST0 & ST1	MPC8240 Internal Registers Initialized
ST0 & IOP	PCI Device Initialization Complete
ACT & ST0 & ST1	FE Diagnostics Starting
ACT	All FE Diagnostics Passed
All LEDs OFF	User application downloaded, LEDs cleared.



## CHAPTER 4 PERIODIC MAINTENANCE

### 4.1 PERIODIC MAINTENANCE

The only element of the FEP unit requiring periodic maintenance is the air filter, located on the left hand side of the unit. The filter should be replaced or cleaned every 12 months in normal operating environments. It should be replaced more often in dusty environments.

The replacement of air filter or fan can be done without turning off the power supplies. The fan and air filter assembly is located on the left hand side of the FEP unit. Replacement filters can be purchased from Cyclone Microsystems, Cyclone part number 370-1303.

**Table 4-1. Air Filter Replacement**

1	Loosen the four screws retaining the Fan & Air Filter access panel.
2	Remove the Fan & Air Filter access panel.
3	Pry out the air filter by pinching the filter and using a medium Phillips screwdriver to pry it outwards. (see Figure 4-1)
4	Insert the new filter and align it into the panel using a medium Phillips screwdriver.
5	Install the Fan & Air Filter access panel.
6	Snug the four thumbscrews using a Phillips screwdriver. <b>DO NOT OVERTIGHTEN, AS THIS WILL CRUSH THE GASKETING MATERIAL AROUND THE ACCESS PANEL.</b>

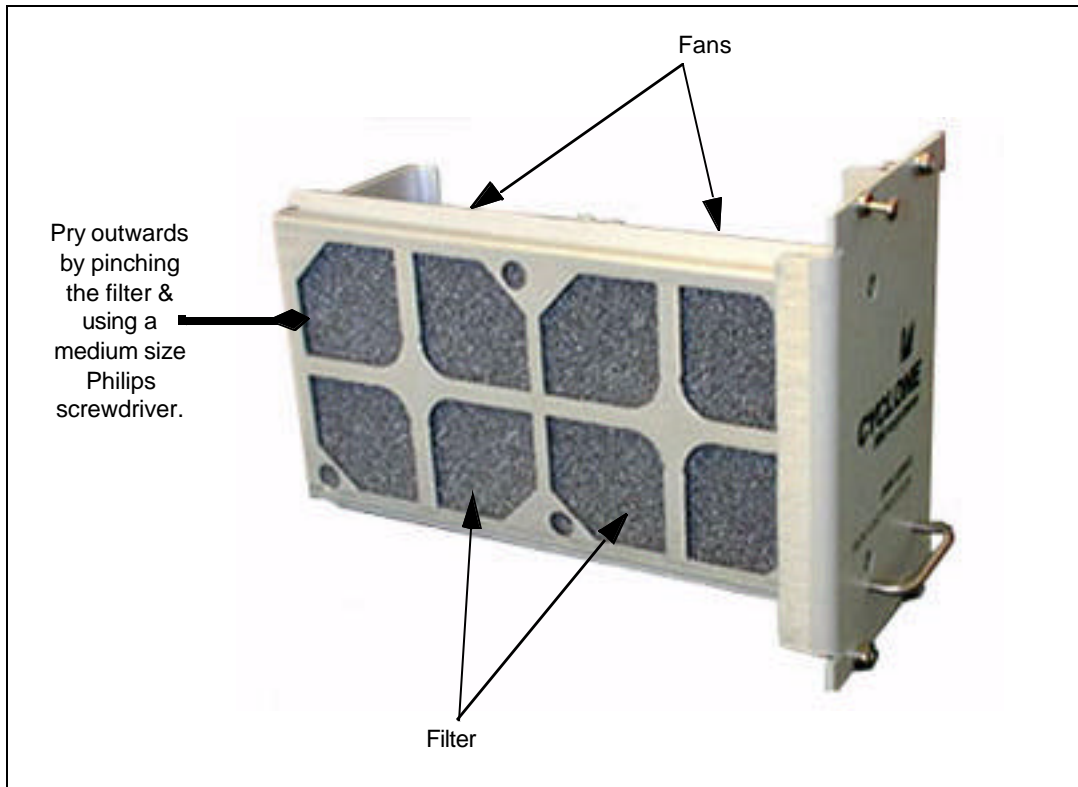

Figure 4-1. Air Filter Replacement



## CHAPTER 5 SERVICEABLE COMPONENTS

### 5.1 SERVICEABLE COMPONENTS

All of the Field Replaceable Units (FRU) of an FEP are serviceable from the front of the unit without the need to dismount an installed FEP from its rack. Table 5-1 lists all the field replaceable units and the associated CLEI codes and Cyclone part numbers.

**Table 5-1. CLEI Number and Barcode**

Cyclone Part Number	Qty	Description	CLEI Number	ECI Code Barcode
<b>600-2400-01-A0</b>				
600-2011	1	5 slot CPCI-AC: 2400 Chassis	GCM2DC0CRA	436787
CM-810-064-00-T3	1	CPCI-810 Host Processor Board	GCP8UTMFAA	113135
CM-811-064-08-T3	1	Data Link Board: 8 Port Serial	GCP7V1WJAA	113137
370-1302	1	AC Power supply: 2400 Chassis	GCPUHT0JAA	272077
370-1300	1	Fan / Filter Assembly: 2400 Chassis	GCNYAANFAA	436784
370-1303		Filter (only): 2400 Chassis		
<b>600-2400-01-D0</b>				
600-2010	1	5 slot CPCI-DC: 2400 Chassis	GCM2ED0CRA	436788
CM-810-064-00-T3	1	CPCI-810 Host Processor Board	GCP8UTMFAA	113135
CM-811-064-08-T3	1	Data Link Board: 8 Port Serial	GCP7V1WJAA	113137
370-1301	1	DC Power supply: 2400 Chassis	GCPUCS0JAA	272075
370-1300	1	Fan / Filter Assembly: 2400 Chassis	GCNYAANFAA	436784
370-1303		Filter (only): 2400 Chassis		

### 5.2 BOARD REMOVAL AND INSTALLATION

The CPCI-810 is not hot-swappable and should only be removed or installed with power OFF. All cables should be disconnected from the boards during installation and removal. CPCI 811-08 Boards are hot swappable and can be removed from the FEP when the power is ON.

#### 5.2.1 Board Removal

FEP Boards can be damaged with electrostatic discharge. Consequently, all boards should be handled in an environment with preventive Electro Static Discharge (ESD) measures. Specifically, boards should only be actively handled with a ground strap and transported in an ESD shielded bag.

Turn power off. Disconnect cables from the board. Loosen the two retaining screws on the boards front panel. The retaining screws are located on each edge of the front panel, between the ejector handles and the end of the front panel. Eject the board by prying outward on both the ejector handles.

### 5.2.2 Board Installation

Insert the board into the FEP unit opening and align the printed circuit board card edge with the card guides inside the unit. Care should be taken to insert the board horizontally (as flat as possible) so as not to interfere with components on the board below or interfere with the underside of the board above. Fully seat the board by pressing firmly on both ejector handles or pressing at the center of the board's front panel.

## 5.3 FAN TRAY REMOVAL AND INSTALLATION

The cooling fans of the FEP are serviceable from the front of the unit. The FEP does NOT have to be removed from its rack to service the fans.

### 5.3.1 Fan / Filter Access Panel Removal

Follow steps 1 through 3 in Table 4-1 to remove the Fan/Filter access panel. The Fan & Filter tray is located on the left side of the unit as shown in Figure 4-1. The oval opening in the fan tray panel is a finger pull. Pull the fan tray from the unit.

### 5.3.2 Fan/Filter Access Panel Installation

Align the flanges in the Fan /Filter access panel with its guides after replacing the fan and slide the Fan/Filter access panel into the unit.

## 5.4 POWER SUPPLY REMOVAL AND INSTALLATION

The AC power supply has 2 switches for 2 power supplies and the DC power supply has a single switch for 2 power supplies. The power supplies of the FEP are serviceable from the front of the unit. The FEP does NOT have to be removed from its rack to service the power supplies. The FEP will operate with one power supply installed. Since the power supplies are hot swappable, they can be removed or installed without switching off the power.

### 5.4.1 Power Supply Removal

The two power supplies of the FEP are located above the boards, at the top of the unit. To remove failed power supply, loosen the two retaining screws, at either end of the power supply. Eject the power supply from the FEP by prying outward on the ejector handle. Pull the power supply from the unit.

### 5.4.2 Power Supply Installation

With the printed circuit board of the power supply aligned with the card guides of the FEP unit, slide the power supply into the FEP. Fully seat the power supply and tighten the retaining screws.

### **7.1 OVERVIEW**

Cyclone Microsystems is a commercial manufacturer of Single Board Computers, Intelligent Communication Controllers and communications systems. Our standard repair cycle for in-warranty or out-of-warranty repair is two weeks. Most of our FEP customers require 24 by 7 support that is far in excess of Cyclone Microsystems' current or anticipated capabilities. Consequently, we highly recommend that FEP customers pursue high availability support from a support organization or pursue an on-site sparing policy in conjunction with a Cyclone Microsystems Expedited Repair Program. Please contact a Cyclone sales representative for a program proposal.

### **7.2 HARDWARE**

Cyclone Microsystems, Inc. (Cyclone) for the period set out below, warrants that its standard products will be free from defects in workmanship or material under normal use and service. Cyclone's obligation under this warranty shall not arise until the Buyer returns the defective product, freight prepaid, to Cyclone. The only responsibilities of Cyclone under this warranty are at its option to replace or repair, without charge, any defective component of such products.

### **7.3 SOFTWARE AND FIRMWARE**

Cyclone warrants that Software and Firmware supplied shall conform to the then current published documentation applicable to such programs. Cyclone, for the effective period of the warranty set out below, will upon written notice from the Buyer documenting the symptoms or the defect, expend its best efforts to resolve software bugs and/or fault. This service shall be without extra charge, and at Cyclone's option may include on-site visit(s) if in its opinion the conditions justify such visit(s).

### **7.4 EFFECTIVE PERIOD OF WARRANTY**

One year from date of delivery.

### **7.5 REPAIRED OR REPLACEMENT PRODUCT (OUT-OF-WARRANTY)**

Cyclone Microsystems, for a period of 30 days, warrants that its out-of-warranty products that are repaired or replaced shall be free from defects in workmanship or material under normal use and service.

Any repair or replacement shall not extend the period within which the warranty can be asserted.

The above warranties do not extend to and shall not apply to:

- Products which have been repaired or altered by other than Cyclone, unless the Buyer has properly altered or repaired the products in accordance with procedures previously approved, in writing, by Cyclone; or
- Products which have been subject to misuse, neglect, accident or improper installation; or

## WARRANTY



- Products not manufactured by Cyclone.

**The foregoing warranty and remedies are exclusive and are made in lieu of all other warranties express or implied, either in fact or by operation of law, statutory or otherwise, including warranties of merchantability and fitness for use. Cyclone neither assumes nor authorizes any other person to assume for it any other liability in connection with the sale, installation or use of its products, and Cyclone makes no warranty whatsoever for products not manufactured by Cyclone or with respect to any non-standard products which have been subject to misuse, neglect, accident, or have been modified by the Buyer. Cyclone shall have no liability for incidental or consequential damages of any kind arising out of the sale, installation, or use of its products.**

### 7.6 SERVICE POLICY

Out of repair warranty will be accomplished expeditiously at a charge published on the current price schedule plus shipping. A full description of the failure must be enclosed with the product.

Shipments arriving at Cyclone without a Return Material Authorization (RMA) number will not be accepted and will be returned to the customer at his cost regardless of warranty status.

#### Return Procedures

Upon determining that repair is required, the customer must:

- Call Cyclone Customer Support at (203) 786-5536 for a RMA number. Please have ready:
  - The serial number of the board (s)
  - The reason for return
- Enclose a detailed description of the failure with the failed unit in a static-shielded protective container.
- Ship unit to: Cyclone Microsystems, 25 Science Park, New Haven, CT 06511, Attn: RMA number
- The RMA is valid for 30 days after issue.



## APPENDIX A MANUALS

### A.1 ADDITIONAL INFORMATION

Additional information for each of the boards used in the FEP can be found in their respective User's Manual. These manuals are available from Cyclone Microsystems.

<b>Part Number</b>	<b>Description</b>
800-0810	CPCI-810 User's Manual
800-0816	CPCI-816 User's Manual